

# 232-E1

Waterproof Rocker Switch, 30 Amp DPDT  
3-Position On-Off-On

<https://www.gamainc.com/product/232-e1/>

# GAMA ELECTRONICS

P.O. Box 1488, Crystal Lake, IL 60039  
Phone: 815-365-9600  
Fax: 815-356-9603  
Email: [gama@gamainc.com](mailto:gama@gamainc.com)  
[www.gamainc.com](http://www.gamainc.com)

## Specifications

- Circuit Code: Double Pole Double Throw On-Off-On
- Rated at 30A @ 12VDC, 18A @ 125VAC, 10A @ 250VAC.
- Terminals: .250 Quick Connect
- Internal gasket & O-rings keep water & dust out of contacts
- UL, CSA & CE Approved
- Black Body & Button

## Circuit Diagram

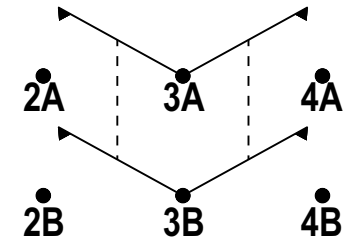

## Mounting Hole

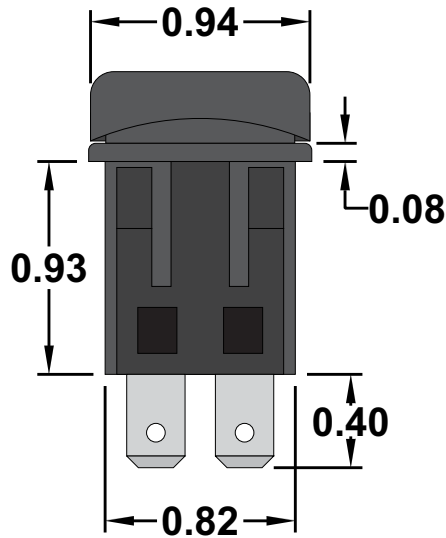
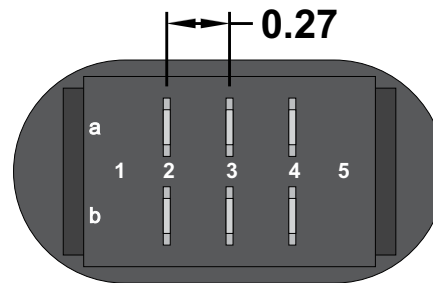
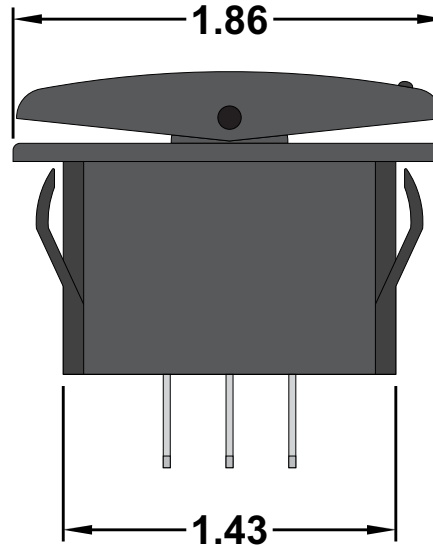
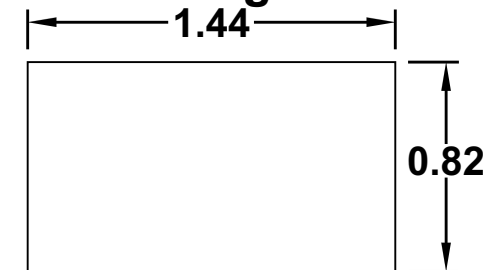

Drawn By: KEG

Information contained herein is proprietary information of GAMA Electronics Inc. The dissemination use or duplication of this information, for any purpose other than that for which the information is provided, is prohibited except by express written permission.

All dimensions are in inches and have a +/- .015" tolerance unless otherwise specified.

Rev: 0

Pg. 1 of 1

Release Date: 01/10/19

Third Angle Projection

