



### Included in this Kit:

- (1) LRF120VPR1L Receiver
- (1) 3-Button Transmitter with Light
- (1) Long Range Antenna LRA340 \*\*See PAGE 3 FOR SETUP\*\*

### Available accessories:

- Wireless Outdoor Keypad KP340-DRC
- 3-Button Waterproof Transmitter KF340-3L-WP
- Rechargeable Transmitter GKF-WPTX-3L
- 3-Button Keyfob Transmitter KF340-3

The LRF120VPR1L is an RF receiver operating at a fixed frequency of 340 MHz. It operates from 120VAC and provides one polarity reversing output for use with a four/six lead AC motor. The receiver is not designed to operate with any existing hand or drum switch. The receiver is equipped with a manual toggle switch. An additional latching output is available for connecting to a 120VAC light. Up to twelve, three-button keyfob transmitters can be used to activate the receiver's relay. The receiver has a terminal block for connecting the power and relay contacts. Each transmitter has a unique address that is transmitted when a button is pressed. A "program" button is provided on the receiver to program the transmitter(s) address into the receiver's memory. An LED on the receiver indicates the receiver's programming status and illuminates when the receiver is energized. The receiver is encased in a waterproof enclosure. The operating range is approximately 500 ft. Operating temperature range is 0°F to 160°F.

**Polarity Reversing Output:** The transmitter has two buttons assigned to the motor output. The up (^) button runs the motor in one direction and the down (v) button runs the motor in the opposite direction. The reversing function accomplished by reversing the phase on two of the four motor connections at the receiver output.

**Manual Switch:** The receiver is equipped with a manual switch. This switch replaces any hand or drum switch previously connected to the motor.

**Light Output:** The light output is activated using the "B" button on the transmitter. Press button "B" once to latch this output on. Press button "B" again to turn the light output off. The light function is active at all times and does not require the power up sequence to be performed.

**Maximum Ratings:** Power for the receiver can be in the range of 100VAC to 132VAC. The relay contacts are rated at 20 Amps.

### Programming Instructions

Each transmitter has its own unique internal address along with the data as to which button is pressed and transmitted. The receiver needs to be programmed to respond only to the specific transmitter it is intended to operate with. The following steps configure the receiver to operate with a particular transmitter. Up to 12 transmitters can be programmed to one receiver. Please read the entire programming procedure before starting. When the receiver enters program mode, all previous transmitter addresses that were programmed will be erased from the receiver's memory.

1. Locate the pushbutton labeled "PROGRAM" on the receiver. Press and hold this button until the red LED next to the program button illuminates (approximately 3 seconds). The receiver is now in the transmitter program mode. Release the button. At this point all previously programmed transmitter addresses are erased from the receiver's memory.
2. To configure the receiver for a latching output, go to Step 4.
3. To configure the receiver for momentary output, press and release either button ONCE on the transmitter and verify that the red program LED extinguishes and then illuminates (blinks once). Proceed to Step 5.
4. To configure the receiver for latching output, press and release either button TWICE on the transmitter and verify that the red program LED extinguishes and illuminates (blinks once).
5. Repeat previous step for additional transmitters that will operate with this particular receiver. The red LED on the receiver will extinguish and illuminate (blink) once for the first transmitter being programmed, twice for the second, three times for the third, etc. The receiver will not respond to transmitters that have already been programmed. The first transmitter that is programmed determines the receiver's relay operating mode.
6. The receiver will return to normal mode if no transmitter buttons are pressed for 5-seconds. The red LED on the receiver will blink rapidly, then extinguish. The receiver is now in the normal mode of operation. This completes the programming instructions. The receiver will retain all of its programming even when power is removed.

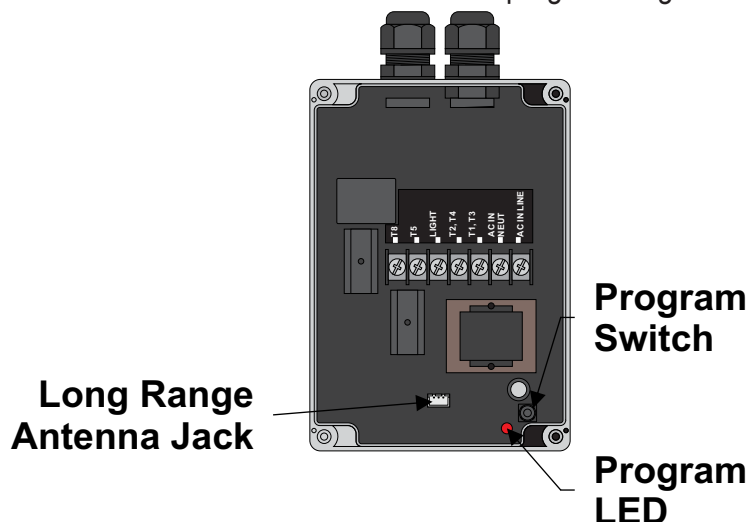

### Wiring Instructions

Prior to this, verify that there is no power at any of the motor terminals.

1. Disconnect or turn off the circuit breaker to remove power (if a hand or drum switch is connected to the motor it will need to be disconnected). Takes notes before disconnecting the switch in the unlikely event it will need to be reconnected.
2. See motor connections using the tables on pages 4 and 5 for terminal connections specific to the motor.
3. 120VAC power is connected to the line and neutral terminal of the receiver.

**NOTE:** After completing the installation, if the motor goes the wrong direction, simply swap the wires connected to T5 and T8 on the receiver. The motor will now rotate in the correct direction. The 120VAC light connects between “common” and “light” terminals on the receiver.

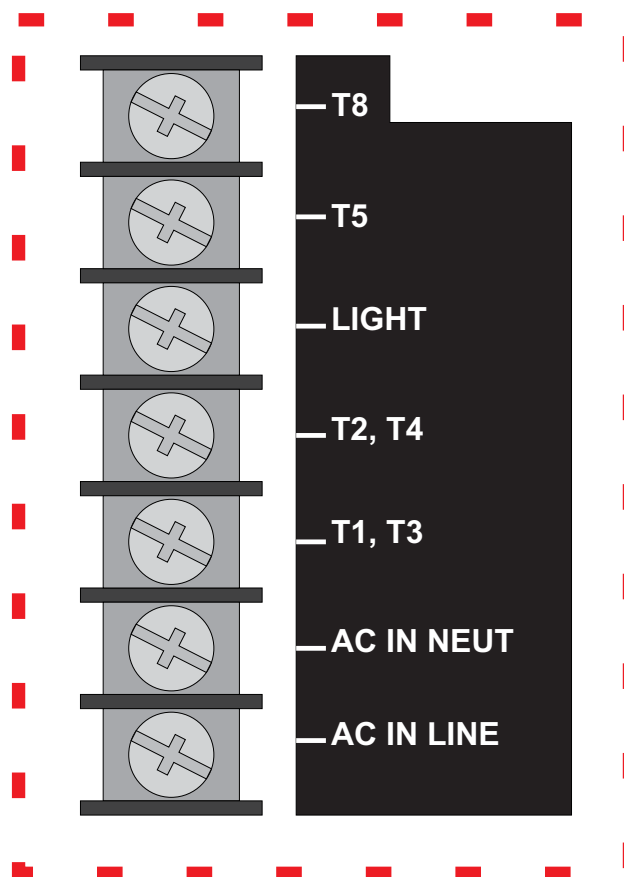

### Schematic

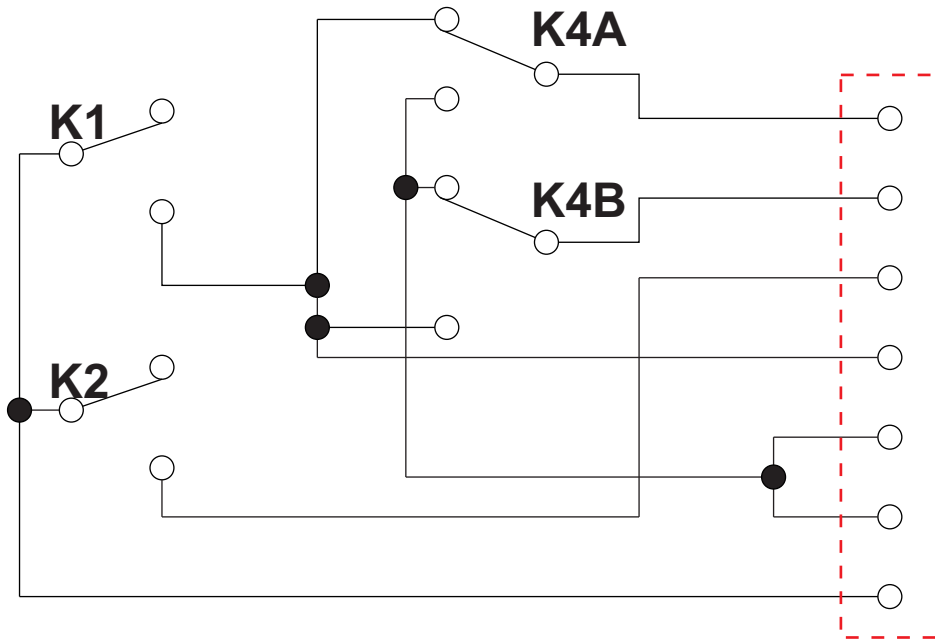

Relays shown in off position

#### Truth Table

K1 = Up or Down  
K4 = Up  
K2 = Light (Latch On/Latch Off)

T8

T5

LIGHT

T2, T4

T1, T3

AC IN NEUT

AC IN LINE

120VAC IN

### **Troubleshooting**

All remote-control systems shipped by GAMA Electronics are 100% functionally tested just prior to shipment.

If your RF remote control system does not work out of the box, stops working or functions intermittently please take the following steps to resolve common issues. Please note that you must be 2-3 feet away from the receiver when operating the remote control. Operating within 2-3 feet may result in no operation or intermittent operation.

#### **1. Replace the A23 12V Battery in the transmitter**

- The remote control can activate during shipping and drain the battery that is installed in the control. We send a replacement battery with the system if this occurs.

#### **2. Check the voltage supply at the receiver**

- The receiver is designed to function at 10-15VDC. Voltage on the (+) and (-) terminals on the control should be within this range.

#### **3. Reprogram the remote control**

- If the system is non-functional try to reprogram the remote control. The program may not have taken during the programming process or the program button may have been pressed. If the program button is pressed the memory of the remote controls programmed to the receiver are erased.

#### **4. Listen and look for functionality on the receiver.**

- The LED that is used for programming the system will illuminate when the receiver is activated. You will also hear a “click” when the internal relays engage. If you can see the LED illuminate and you hear the relay “click” the issue is most likely in the wiring or device being controlled.

#### **5. Add a long-range antenna**

- If the receiver is in an area that is averse to the reception of an RF signal, such as near a motor or in a metal casing, a long-range antenna may solve the issue. Connect the antenna per the instructions on page 3 and mount the antenna in an exposed area away from any motor.

# **GAMA ELECTRONICS**

**WWW.GAMAINC.COM**

## **LRF120VPR1L Instruction Manual**

<b>Motor Name</b>	<b>Figure</b>
STANDARD MOTOR WITH "T" NUMBERS	See Figure 1
STANDARD MOTOR WITH COLORED WIRE	See Figure 2
A.O Smith with L1, L2 Terminals & Colored Wire	See Figure 3
A.O. Smith C426 Motors with Terminals & Colored Wires	See Figure 6
A.O. Smith C526 Motors with Terminals & Colored Wire	See Figure 6
A.O. Smith C926 Motor with Colored Wire	See Figure 7
A.O. Smith Motor 7-181021-20	See Figure 19
A.O. Smith Motor C56A31B17	See Figure 20
A.O. Smith Motor C56B05B17	See Figure 20
A.O. Smith Motor	See Figure 11
Ace Motors with Terminals	See Figure 8
Baldor Motor CPI2000	See Figure 16
Baldor Motor Type LC, DV	See Figure 17
Baldor Motors with L1, L2 Terminals & Colored Wire	See Figure 3
Century AC Motors with Colored Wire	See Figure 7
Century AC Motors with Terminals & Colored Wire	See Figure 6
Century Motors with Terminals	See Figure 4
Dayton Motor 6K719L (Thermal Protection)	See Figure 22
Eastbay Motors with Terminals	See Figure 5
Elite Pointed Motors	See Figure 12
Emerson Motors with Terminals	See Figure 10
GE Motors with Terminals & Colored Wire	See Figure 9
Leeson Motor M6K17F61A	See Figure 21
Leeson Motors with Terminals	See Figure 8
Leeson Type Motor (with Protector) M6C17FB10	See Figure 18
Magnetek Motor 8-181021-20	See Figure 23
Magnetek Motors with Terminals	See Figure 4
Marathon Motor 5KC42JN0214 (3/4 HP)	See Figure 15
Marathon Motor 5KC49PN0216 (1 HP)	See Figure 15
Marathon Motor 5KC49TN0063Y	See Figure 24
Marathon Motor 5KCP35KNB057AS	See Figure 24
Marathon Motor 7PJ56C17F5945	See Figure 21
Marathon Motors with Terminals & Colored Wire	See Figure 9
Powerfist Motor 8703050	See Figure 18
Regal Beloit Motor	See Figure 11
Regal Beloit Motor 52A105379AA	See Figure 13
Regal Beloit Motor C56AD36B17	See Figure 14
Regal Beloit Motor with Type K Protector	See Figure 18
WEG Motor with Protection	See Figure 25

FIGURE 1

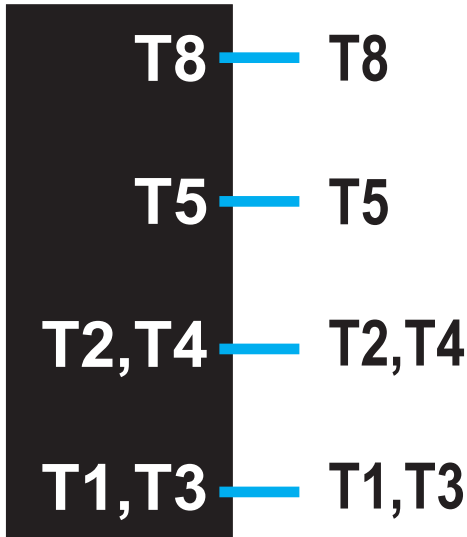

FIGURE 2



\*USE WIRE NUTS TO CONNECT  
THE RECEIVER TO MOTOR WIRES

FIGURE 3

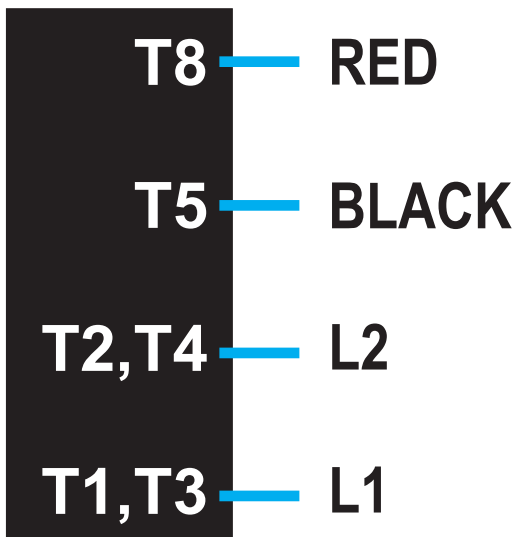
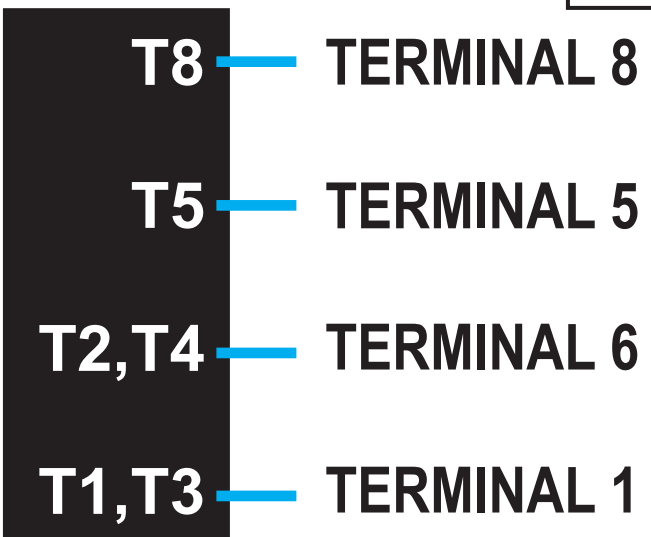

FIGURE 4



\*USE WIRE NUTS TO CONNECT  
THE RECEIVER TO MOTOR WIRES

FIGURE 5

T8 — TERMINAL B

T5 — TERMINAL A

T2,T4 — TERMINAL D

T1,T3 — TERMINAL E

FIGURE 6

T8 — Motor Red \*Use blue wire nut  
to connect the receiver to motor wire

T5 — TERMINAL 5

T2,T4 — TERMINAL 6

T1,T3 — TERMINAL 1

\*MOTOR WIRES BROWN & ORANGE  
MUST BE CONNECTED TO TERMINAL 3

FIGURE 7

T8 — RED

T5 — YELLOW

T2,T4 — BLUE

T1,T3 — BLACK

FIGURE 8

T8 — TERMINAL 3

T5 — TERMINAL 5

T2,T4 — TERMINAL 2

T1,T3 — TERMINAL 1



FIGURE 9

T8 — TERMINAL 2  
T5 — MOTOR RED  
T2,T4 — MOTOR YELLOW  
& WHITE  
T1,T3 — TERMINAL 1

\*USE BLUE WIRE NUTS TO CONNECT THE  
RECEIVER TO MOTOR WIRES

FIGURE 10

T8 — TERMINAL 2  
T5 — TERMINAL 4  
T2,T4 — TERMINAL 1  
T1,T3 — TERMINAL 3

FIGURE 11

T8 — RED  
T5 — ORANGE  
T2,T4 — WHITE  
T1,T3 — BLACK

FIGURE 12

T8 — RED  
T5 — BLACK  
T2,T4 — WHITE  
T1,T3 — ORANGE

# GAMA ELECTRONICS

WWW.GAMAINC.COM

## LRF120VPR1L Instruction Manual



FIGURE 14

Included in this Kit:

- T8 — **RED** 1L Receiver Transmitter with Light
- T5 — **BLACK** 120VAC Light Antenna LRA340 \*\*See PAGE 3 FOR SETUP\*\*
- T2, T4 — **ORANGE** Accessories: 120VAC Door Keypad KP340-DRC
- T1, T3 — **WHITE** Waterproof Transmitter KF340-3L-WP
- T2, T4 — **ORANGE** 1 (BLUE) 120VAC Transmitter
- T1, T3 — **WHITE** L2 (WHITE) 120VAC Transmitter KF340-3

The LRF120VPR1L is an RF receiver operating at a fixed frequency of 340 MHz. It operates from 120VAC and provides one polarity reversing output for use with a four/six lead AC motor. The receiver is not designed to operate with any existing hand or drum switch. The receiver is equipped with a manual toggle switch. An additional latching output is available for connecting to a 120VAC light. Up to twelve, three-button keyfob transmitters can be used to activate the receiver's relay. The receiver has a terminal block for connecting the power and relay contacts. Each transmitter has a

FIGURE 15

FIGURE 16

unique address that is transmitted when a button is pressed. A "program" button is provided on the receiver to program the address into the receiver's memory. An LED indicates when the receiver is energized. The receiver is housed in a weatherproof enclosure. The operating range is 1000 ft. Operating temperature range is 0°F to 100°F.

The receiver's programming status is indicated by the receiver's programming status LED. The receiver is housed in a weatherproof enclosure. The operating range is 1000 ft. Operating temperature range is 0°F to 100°F.

The receiver has two buttons: the up (^) button runs the motor in one direction and the down (v) button runs the motor in the opposite direction. The reversing function reverses the phase on two of the four motor leads. The receiver is equipped with a manual switch for use with a hand or drum switch previously used with the motor.

The receiver has two buttons: the up (^) button runs the motor in one direction and the down (v) button runs the motor in the opposite direction. The reversing function reverses the phase on two of the four motor leads. The receiver is equipped with a manual switch for use with a hand or drum switch previously used with the motor.

The light output is activated using the "B" button. Press button "B" once to latch this output on. Press button "B" again to turn the light output off. The light function is active at all times and does not require the power up sequence to be performed.

Press button "B" once to latch this output on. Press button "B" again to turn the light output off. The light function is active at all times and does not require the power up sequence to be performed.

**Maximum Ratings:** Power for the receiver can be in the range of 100VAC to 132VAC. The relay contacts are rated at 20 Amps.

**\*4-NEUTRAL IN FROM AC POWER SOURCE**  
**\*LINE OF RECEIVER TO LINE OF AC POWER SOURCE**

FIGURE 17

T8	8 RED
T5	5 BLACK
T2,T4	2 WHITE/4 YELLOW
T1,T3	1 BLUE/3 ORANGE

FIGURE 18

T8	T8
T5	T5
T2,T4	T2, T4
T1,T3	<b>NO CONNECTION</b>

\*P2, T3-NEUTRAL FROM AC INPUT

\*P1-NEUTRAL FROM AC INPUT

FIGURE 19

T8	5
T5	RED 2
T2,T4	YELLOW/WHITE
T1,T3	BLUE/ORANGE

\*BLACK 4- NO CONNECTION

FIGURE 20

T8	RED
T5	BLACK
T2,T4	L2
T1,T3	L1

FIGURE 21



\*ORANGE/P2-NEUTRAL ON RECEIVER  
\*P1-NEUTRAL AC INPUT

FIGURE 22

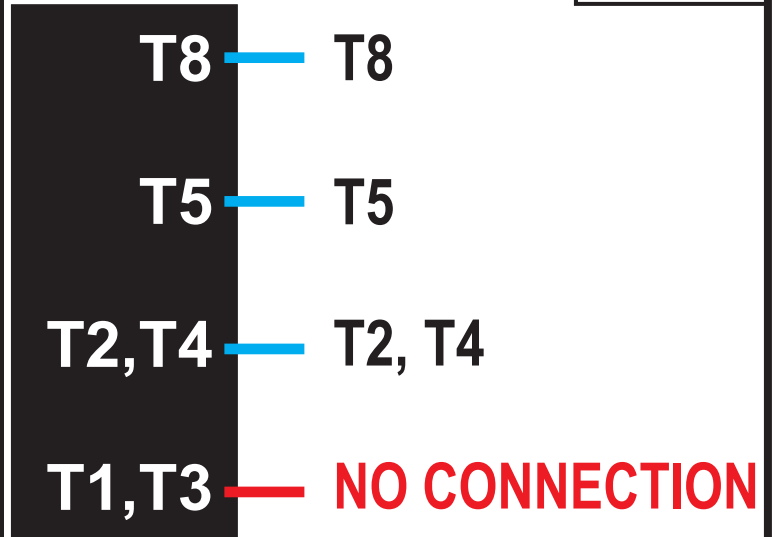

\*P2, T3-NEUTRAL  
\*P1-NEUTRAL AC INPUT

FIGURE 23

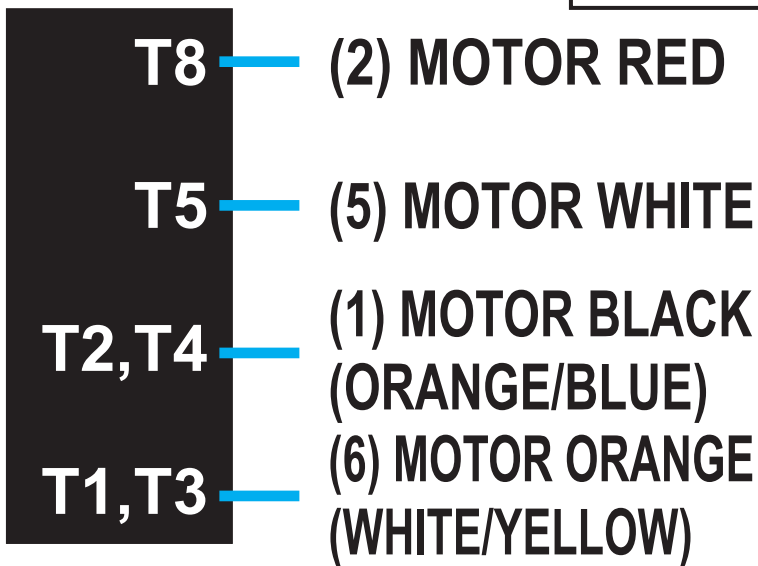
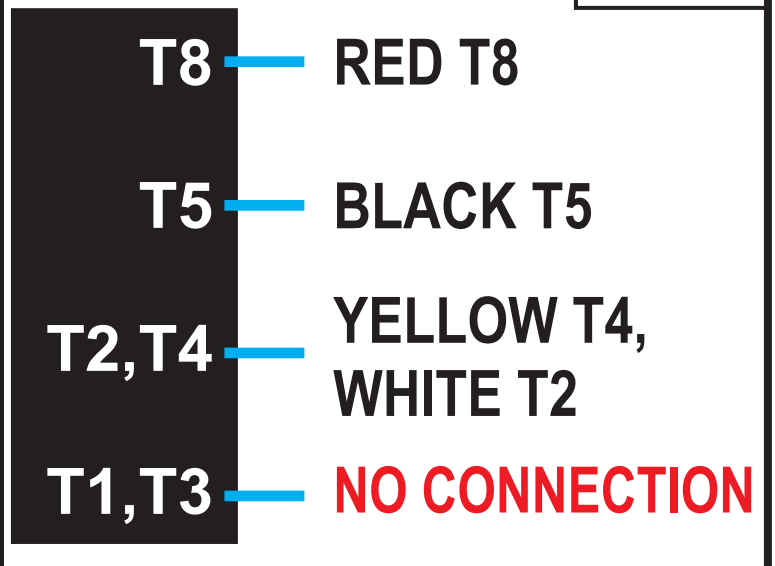

FIGURE 24



\*BROWN P2 ORANGE T3-NEUTRAL  
\*PURPLE P1-AC INPUT NEUTRAL

FIGURE 25

<b>T8</b>	<b>—</b>	<b>RED (8)</b>
<b>T5</b>	<b>—</b>	<b>BLACK (5)</b>
<b>T2,T4</b>	<b>—</b>	<b>BLUE (1) ORANGE (3)</b>
<b>T1,T3</b>	<b>—</b>	<b>NO CONNECTION</b>

\*WHITE (2) BROWN (7/P2)-NEUTRAL

\*YELLOW (4)-AC INPUT NEUTRAL