

P44066

3-Button Keyfob Transmitter with On/Off Button

<https://www.gamainc.com/product/p44066/>

GAMA ELECTRONICS

P.O. Box 1488, Crystal Lake, IL 60039

Phone: 815-365-9600

Fax: 815-356-9603

Email: gama@gamainc.com

www.gamainc.com

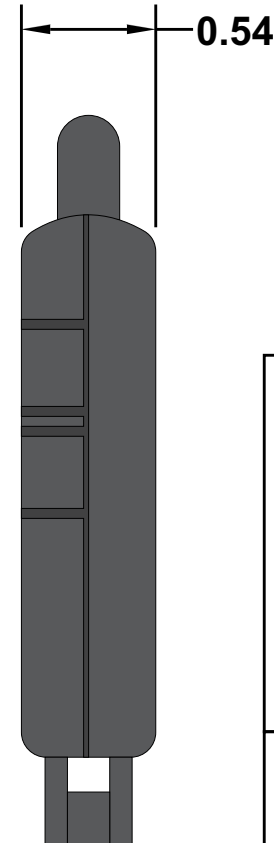
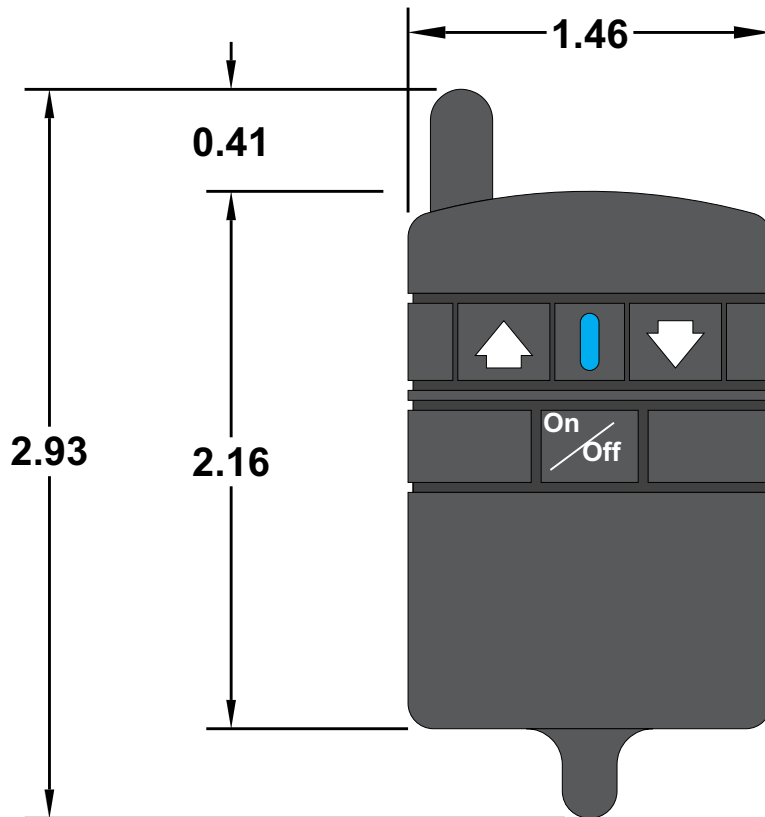

Specifications

- Three Button Transmitter
- Frequency: 340 MHz
- Keychain lanyard included
- Blue LED indicates transmission
- Uses 1 A23 12V Battery
- Each transmitter has the option to be standard, waterproof, or re-chargeable

Accessories Sold Separately

- Package of 6 A23 12V Alkaline Keyfob Batteries (A23-6)

Drawn By: KEG

Information contained herein is proprietary information of GAMA Electronics Inc. The dissemination use or duplication of this information, for any purpose other than that for which the information is provided, is prohibited except by express written permission.

All dimensions are in inches and have a +/- .015" tolerance unless otherwise specified.

Rev: 0

Pg. 1 of 1

Release Date: 10/31/18

Third Angle Projection

